



**MANUAL DE UTILIZARE / USER'S MANUAL
MASINA SLEFUIT CU BANDA / BELT SANDER
BS800**



Parti componente / Parts

1. Maner frontal / Front handle
2. Capac perii colectoare / Carbon brush cover
3. Comutator pornit –oprit / On-Off trigger
4. Buton functionare continua / Continuous mode knob
5. Maner principal / Main handle
6. Duza evacuare praf / Dust exhaust nozzle
7. Buton centrare banda / Belt centring knob
8. Banda abraziva / Sanding belt
9. Levier blocare / Clamping lever

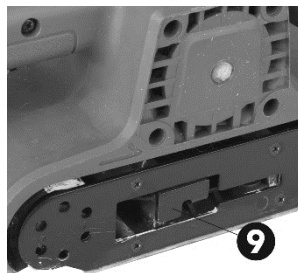
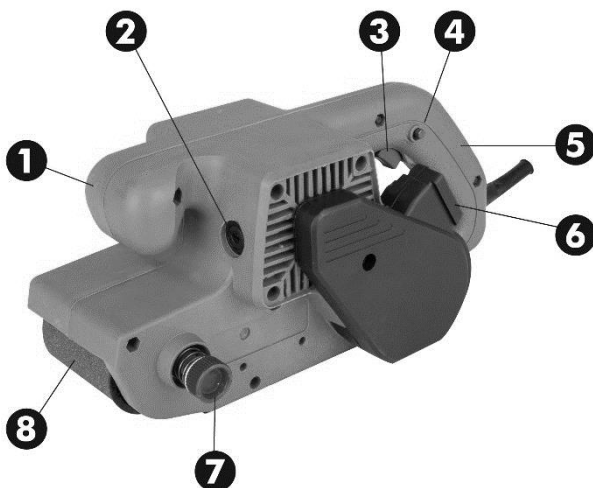

Accesorii / Accessories

- 1 Sac colectare praf / 1 Dust bag
- 1 Pereche perii colectoare / 1 Pair carbon brush
- 3 Benzi abrazive / 3 Sanding belt
- 1 Curea transmisie / 1 Transmission belt

Date tehnice / Technical info

Tensiune- Frecventa / Voltage - Frequency	230-240V ~ 50Hz
Putere nominala / Nominal power	800W
Turatie / Speed	380 m / min
Dimensiune banda abraziva / Sanding belt dimensions	533 x76 mm
Nivel zgomot / Sound power level	LwA=97 dB(A), k=3dB(A)
Nivel vibratii / Vibration level	3.92 m/s ² k=1.5m/s ²
Clasa protectie / IP rating	IP20
Greutate / Weight	3.5 Kg







Va multumim pentru achizitionarea acestui produs EVOTOOLS, fabricat conform celor mai inalte standarde de siguranta si de functionare.



Avertizare! Pentru siguranta dumneavoastra cititi cu atentie acest manual si instructiunile generale de siguranta inaintea utilizarii echipamentului. Nerespectarea acestor reguli poate avea ca rezultat producerea electrocutarilor, a incendiilor si/sau a ranirilor personale

Simboluri

Simbolurile utilizate in manual sau pe produs au urmatoarele semnificatii:

	Atentie!		Purtati ochelari de protectie
	Cititi manualul de utilizare		Purtati masca de protectie
	Produsul este in conformitate cu standardele de siguranta ale Directivelor Europene		Izolatie dubla

Masuri de siguranta generale pentru uneltele electrice

Zona de lucru

- Pastrati zona de lucru curata si bine iluminata. Umiditatea si zonele intunecate pot crea accidente
- Nu utilizati unealta in zonele cu potential exploziv, de exemplu in prezenta lichidelor, gazelor sau particulelor inflamabile. Uneltele electrice genereaza scantei care pot aprinde aceste materiale.
- Nu lasati copii sau persoanele neautorizate in zona de lucru. Distragerea atentiei poate cauza pierderea controlului uneltei.

Masuri de siguranta a echipamentului in exploatare



ATENTIE! Verificati intotdeauna ca tensiunea de alimentare sa corespunda cu cea inscrisa pe placuta uneltei.

- Nu rasuciti cablul electric de alimentare al uneltei !
- Nu transportati unealta tinand-o de cablul electric si nu trageti de cablul electric pentru a o scoate din priza.
- Tineti cablul electric de alimentare a masinii la distanta fata de sursele de caldura, de pete de ulei, de grasimi, de obiectele ascutite si sursele care emana caldura.
- Verificati stecherul si cablul electric in mod regulat si in caz de deteriorare a acestora apelati la un electrician autorizat.
- Evitati pornirile accidentale ale uneltei.
- Nu utilizati unealta in conditii de ploaie sau umiditate excesiva. Patrunderea apei in interiorul uneltei creste riscul unui scurtcircuit.
- Folositi cabluri de prelungire care sunt atestate si marcate in mod corespunzator pentru utilizarea in mediul exterior.
- Nu suprasolicitati unealta electrica! Masina poate fi folosita in conditii de siguranta daca sunt

respectati parametrii de exploatare care o caracterizeaza. Nu utilizati unelte electrice cu un alt scop fata de cel pentru care sunt destinate.

Masuri de siguranta personala

- Intotdeauna utilizati o imbracaminte adecvata. Nu purtati haine largi sau bijuterii. Daca aveti parul lung, acesta trebuie legat. Apare riscul prinderii acestora de catre partile componente ale masinii aflate in miscare.
- Utilizati echipament de protectie : ochelari si masca de praf. Unele materiale prelucrate pot contine substante toxice sau periculoase, ca de exemplu vopsea pe baza de plumb

Informatii generale

- Valoarea totala declarata a nivelului vibratiilor a fost masurata cu metode standard si poate fi utilizata pentru compararea intre ele a produselor echivalente. Poate fi de asemenea utilizata pentru evaluarea preliminara a nivelului de expunere
- Nivelul vibratiilor acestui produs in utilizarea normala poate fi diferit de cel declarat, in functie de modul cum este exploatat.
- Trebuie luate masurile corespunzatoare pentru protejarea utilizatorului , conform nivelului estimat al expunerii pe perioada utilizarii produsului

Service

- Repararea trebuie realizata numai de catre personal autorizat prin inlocuirea cu accesorii si piese de schimb originale pentru a se evita producerea accidentelor datorate reparatiilor necorespunzatoare.

Masuri de siguranta specifice masinii de slefuit cu banda

- Nu folositi lichide pe suprafata de prelucrat intrucat masina nu este etansa la lichide
- Nu lasati masina sa functioneze libera, fara a fi tinuta ferm cu ambele maini.
- Spatiul in care se executa slefuirea trebuie sa fie foarte bine ventilat. De cate ori este posibil, utilizati un aspirator pentru colectarea prafului rezultat din prelucrare
- Inainte de fiecare utilizare verificati integritatea suportului (5). Eventualele fisuri pot provoca vatamari corporale.

Domeniu de utilizare.

Masina de slefuit cu banda este utilizata pentru slefuirea suprafetelor de lemn, plastic si metal precum si a suprafetelor vopsite.

NU ESTE PROIECTATA PENTRU UZ INDUSTRIAL.

Pregatirea pentru punerea in functiune



ATENTIE! Deconectati alimentarea cu energie electrica inaintea inceperii oricarei operatiuni de reglare sau intretinere.

Montare sac colectare praf

Aceasta masina se poate conecta la un aspirator sau la sacul de colectare a prafului prin duza de evacuare (6). Va recomandam sa utilizati permanent aceste accesorii

Montare / demontare banda abraziva

1. Slabiti levierul de blocare (9) si trageți-l in exterior pana in pozitia maxima. Atentie la posibilul recul datorat arcului de tensionare a levierului
2. Pozitionati corect banda abraziva (8) cu granulatia dorita pe cele 2 role. Asigurati-va ca zonele laterale ale benzii nu ating carcasa slefuitorului si ca este respectat sensul de rotatie



ATENTIE! Banda abraziva are sensul de rotatie indicat pe interior

3. Deplasati levierul in pozitia de blocare. Asigurati-va ca levierul este impins la maxim.

Centrarea benzii abrazive

Verificați ca banda abraziva să funcționeze central înainte de utilizare. Aceasta operatiune este necesara pentru a preveni rulara benzii in exteriorul rolor. Rotiți mașina cu banda îndreptată spre operator. Porniți mașina de șlefuit și observați cum funcționează banda abraziva. In cazul deplasarii de-a lungul rolor în ambele direcții (stanga sau dreapta), este necesara centrarea. Rotiți butonul de centrare (7) în sensul acelor de ceasornic sau în sens antiorar pentru a ajusta pozitia benzii până când aceasta se mișcă central. Porniți șlefuitorul pentru o perioadă scurtă de timp. Dacă banda nu funcționează în continuare in centru, utilizați butonul de centrare pentru reglarea fină a poziției.

Utilizare



ATENȚIE! IN CAZUL IN CARE APAR ZGOMOTE ANORMALE IN FUNCTIONARE OPRIȚI IMEDIAT UNEALTA SI ADRESATI-VA UNUI SERVICE AUTORIZAT PENTRU CONSTATARI SI REPARATII.



ATENȚIE! Nu utilizați niciodata masina fara banda abraziva.



ATENȚIE!Nu prelucrați niciodata piese din magneziu.

Pornire/oprire

- Pentru pornirea masinii apasati comutatorul (3) iar pentru oprire eliberati-l.
- Pentru functionare in regim continuu apasati in acelasi timp butoanele (3) si (4). Pentru intreruperea functionarii continue apasati din nou comutatorul (3).

Slefuire

- Tineti masina ferm si dupa ce o porniti asteptati sa atinga turatia maxima. **ATENȚIE! Initial mașina de șlefuit se poate deplasa brusc înainte.**
- Pozitionati-o cu grija paralel cu suprafata de prelucrat si aplicati o presiune usoara asupra masinii .Aplicarea unei presiuni ridicate poate reduce durata de viata a masinii si eficienta slefuirii.
- Pentru o prelucrare de calitate mentineti un ritm de deplasare constant.
- Dupa terminarea lucrului ridicati masina de pe suprafata de prelucrat si apasati comutatorul (3) pentru oprire
- Asteptati pana la oprirea completa a motorului inainte sa asezati masina pe bancul de lucru.

Curatare si intretinere



ATENȚIE! Inainte de orice interventie asupra echipamentului, deconectati alimentarea cu energie electrica de la retea.

Inlocuire perii colectoare



ATENȚIE!Intotdeauna se inlocuiesc ambele perii colectoare

- Pozitionati slefuitorul pe bancul de lucru si demontati capacele de protectie (2) ale periiilor
- Indepartati perile uzate si introduceti perile noi in suport
- Montati inapoi si fixati capacele de protectie.

Curatare

- Regulat, de preferat dupa fiecare utilizare curatati echipamentul cu o carpa moale. Daca murdaria persista, utilizati o carpa umezita intr-o solutie de apa si sapun.
- NU utilizati solventi (ca de exemplu : petrol si derivati, alcool) intrucat acestia pot deteriora partile din plastic.

Intretinere

Echipamentul nostru a fost proiectat astfel incat sa poata fi utilizat pentru o perioada indelungata cu un minimum de intretinere. Veti putea obtine intotdeauna o satisfactie maxima in timpul utilizarii respectand indicatiile de mai sus.

Depozitare

- Depozitati unealta electrica intr-un spatiu inaccesibil copiilor intr-o pozitie stabila si sigura intr-un loc racoros si uscat, evitand temperaturile prea ridicate sau scazute.
- Protejati unealta electrica fata de actiunea directa a razelor solare si pastrati-o intr-un loc intunecos, daca este posibil.
- Nu pastrati masina ambalata in folie sau punga de plastic pentru a evita acumularea umiditatii.

Garantie

Garantia acopera toate materialele componente si viciile de fabricatie cu exceptia, fara insa a fi limitate la:

- Componente sau accesorii uzate ca urmare a unei exploatare normale
- Defecte cauzate de o exploatare intretinere, depozitare necorespunzatoare, modificari neautorizate asupra echipamentului, costul transportului.
- Pagube materiale si leziuni corporale rezultate in urma exploatarei necorespunzatoare a echipamentului.
- Deteriorari cauzate de lichide, patrundere excesiva de praf, distrugere intentionata , utilizare inadecvata (pentru scopuri in care acest echipament nu este proiectat), etc..

HONEST GENERAL TRADING SRL își rezervă dreptul de modificare a programului de livrare în ceea ce privește forma, tehnologia și echiparea.

Prin urmare nu pot fi ridicate pretenții cu privire la informațiile și figurile din acest Manual de utilizare.



Acest produs este un echipament electric si electronic (EEE). Conform prevederilor Directivei 2012/19/UE si OUG 5/2015, este interzisa eliminarea deseurilor de echipamente electrice si electronice (DEEE) ca deseuri municipale nesortate. Acestea pot afecta mediul si sanatatea umana ca urmare a prezentei substantelor periculoase pe care le contin. Predati DEEE la un centru autorizat de colectare si reciclare a DEEE.

Thank you for buying this EVOTOOLS product, manufactured according to the highest safety and performance standards.



WARNING! For your own safety, read this manual and the general safety instructions carefully before using the appliance. Your power tool should only be given to other users together with these instructions.

Symbols

In this manual and/or on the machine the following symbols are used:

	Warning/Danger!		wear eye protection
	Read manual before use		Wear dust mask protection
	In accordance with essential applicable safety standards of European directives		Double insulated

Working area

- Keep working area clean and well lit. Untidy and dark areas can lead to accidents.
- Do not operate power tools in potentially explosive surroundings, for example, in the presence of inflammable liquids, gases or dust. Power tools create sparks which may ignite the dust or fumes.
- Keep children and bystanders at a distance when operating a power tool. Distractions can cause you to lose control of it.

Electrical safety



Always check that the power supply corresponds to the voltage on the rating plate.

- Do not expose power tools to rain or wet conditions. Water entering a power tool will increase the risk of electric shock.
- Do not abuse the cord. Never use the cord for carrying, pulling or unplugging the power tool. Keep cord away from heat, oil, sharp edges or moving parts. Damaged or entangled cords increase the risk of electric shock.
- When operating a power tool outdoors, use an extension cord suitable for outdoor use. Use of a cord suitable for outdoor use reduces the risk of electric shock.

Declaration

- The vibrations by the tool in normal use may differ from the declared value depending on how it is used.
- Appropriate measures must be taken to protect the user based on an estimate of exposure during normal use of the tool.

Personal safety

- Dress properly. Do not wear loose clothing or jewellery. Keep your hair, clothing and gloves away from the power tool. Loose clothes, jewellery or long hair can become entangled in the moving parts.
- Use safety equipment. Always wear eye protection. Using safety equipment such as a dust mask, non-skid safety shoes, a hard hat, or hearing protection whenever it is needed will reduce the risk of personal injury.

Service

Your power tool should be serviced by a qualified specialist using only standard spare parts. This will ensure that it meets the required safety standards.

Specific safety instructions for finishing sander

- Do not use liquid on the surface to be processed because the machine is not waterproof.
- Never leave the machine to operate freely, without being held firmly with both hands
- The space that runs sanding must be well ventilated. Whenever possible, use a vacuum extractor for dust collection
- Before each use check the integrity of the support (5). Any cracks can cause injuries.

Application

Finishing sander is used for polishing surfaces of wood, plastic, metal and painted surfaces. IT IS NOT DESIGNED FOR PROFESSIONAL USE.

Assembly



Disconnect the power plug before carrying out any adjustments or maintenance.

Using the dust extraction connection

This machine is fitted with a dust extraction outlet (6) and collection bag. We recommend to use this facility at all times,

Replacing the Sanding belts

Locate the belt tension lever (9) and pull outwards. Take care as the lever is under tension and may spring back to the closed position. Continue pulling the lever outwards until it locks in the position.



NOTE: The Sanding belt has directional arrows printed on the inside of the belt

Sanding belts come in different grades i.e. rough through to smooth. Select the grade according to the material operated on.

Locate the sanding belt (8) on the rollers. Make sure the sanding belt does not touch the sides of the casing and that the arrows, printed on the inside of the sanding belt point in the direction of travel. Release the tension lever.

Caution is required as the lever is under spring tension. Make sure the lever closes fully.

Centralizing the sanding belt

Check that the sanding belt is running centrally before using. Centralizing the belt is necessary to stop the belt running off the rollers. Turn the machine with the belt facing the operator Start the Sander and observe how the sanding belt is running. If the sanding belt is seen to move along the rollers in either direction, it will require centralizing before use.

Turn the centralizing knob (7) either clockwise or anti-clockwise to adjust the belt tracking until the sanding belt is running centrally. Run the Sander for a short time. If the belt is still not running centrally, use the centralizing knob to fine adjust the position of the sanding belt.

Operation



WARNING! In case of any abnormal noise, immediately turn off the tool and contact an authorized service facility for repairs



WARNING! Never use machine without sanding paper



WARNING! Never use machine for sanding magnesium workpieces

Start / stop

To start machine press switch (3) and release it to stop.

To switch the machine to continuous mode keep the switch (3) fully pressed and simultaneously press the lock button (4). To switch off continuous mode press the on/off switch again.

Using the Belt Sander

- Hold the machine with both hands and assume a balanced posture. Press the On/Off trigger switch and allow the motor to reach full speed.
- Hold the machine parallel to the work piece. Gently bring belt contact with the work piece. A high pressure can reduce the lifetime of the machine and polishing efficiency.



Caution! The sander may initially snatch forwards. Resist the forwards motion and allow the sander to move forwards at a gradual pace.

- Do not use excessive, downward pressure, this may cause the belt to snap. Keep the sander moving forwards at an even pace. Failure to do this will result in an uneven finish.
- When the operation finished, lift the sander clear of the workpiece and release the On/Off trigger switch.
- Wait until the belt has stopped rotating before putting the sander down on workbench. Failure to do this will result in the machine running forwards.

Cleaning and maintenance



Before performing any work on the equipment, pull the power plug.

Carbon brush replacement

Place the sander on a workbench and using a screwdriver remove the carbon brush housing cover (2)

Remove the carbon brush from the brush housing and replace it with a new one. Slide the new carbon brush into the brush housing. Repeat this procedure for the other carbon brush. Then replace the carbon brush housing cover.

Note: carbon brushes must be replaced in pairs.

Cleaning

- Regularly clean the machine housing with a soft cloth, preferably after each use. If the dirt does not come off use a soft cloth moistened with soapy water.
- Never use solvents such as petrol, alcohol, ammonia water, etc. These solvents may damage the plastic parts.

Maintenance

Our machines have been designed to operate over a long period of time with a minimum of

maintenance. Continuous satisfactory operation depends upon proper machine care and regular cleaning.

Storage

- Thoroughly clean the whole machine and its accessories.
- Store it out of the reach of children, in a stable and secure position, in a cool and dry place, avoid too high and too low temperatures.
- Protect it from exposure to direct sunlight. Keep it in the dark, if possible.
- Don't keep it in plastic bags to avoid humidity build-up.

Warranty

This warranty covers all material or production flaws excluding:

- Defective parts subject to normal wear & tear such as bearings, brushes, cables, and plugs, or accessories.;
- Damage or defects resulting from maltreatment, accidents or alterations; nor the transportation cost
- We disclaim all liability for any bodily injury resulting from inappropriate use of the tool.
- Definitely excluded from the warranty is damage resulting from fluid permeation, excessive dust penetration, intentional damage (on purpose or by gross carelessness), inappropriate usage, incompetent usage (e.g. not following the instructions given in the manual), inexpert assembly, lightning strike, erroneous net voltage. This list is not exhaustive.



Acest produs este un echipament electric si electronic (EEE). Conform prevederilor Directivei 2012/19/UE si OUG 5/2015, este interzisa eliminarea deseurilor de echipamente electrice si electronice (DEEE) ca deseuri municipale nesortate. Acestea pot afecta mediul si sanatatea umana ca urmare a prezentei substantelor periculoase pe care le contin. Predati DEEE la un centru autorizat de colectare si reciclare a DEEE.