



## PV Grid Tie Inverter

# Solis 4G Mini Single Phase Inverter

### Installation and Operation Manual

Solis-mini-700-4G, Solis-mini-1000-4G, Solis-mini-1500-4G, Solis-mini-2000-4G,  
Solis-mini-2500-4G, Solis-mini-3000-4G, Solis-mini-3600-4G



Ningbo Ginlong Technologies Co., Ltd.

No. 57 Jintong Road, Binhai Industrial Park, Xiangshan, Ningbo,  
Zhejiang, 315712, P.R.China.

Tel: +86 (0)574 6578 1806

Fax: +86 (0)574 6578 1606

Email: info@ginlong.com

Web: www.ginlong.com

If you encounter any problem on the inverter, please find out the inverter S/N  
and contact us, we will try to respond to your question ASAP.



© 2016, Ningbo Ginlong Technologies Co., Ltd.

# Contents

1. Introduction .....	3
1.1 Product Description .....	3
1.2 Packaging .....	4
2. Safety Instructions .....	5
2.1 Safety Symbols .....	5
2.2 General Safety Instructions .....	5
2.3 Notice For Use .....	6
3. Overview .....	7
3.1 Front Panel Display .....	7
3.2 LED Status Indicator Lights .....	7
3.3 Keypad .....	8
3.4 LCD .....	8
4. Installation .....	9
4.1 Select Location for the Inverter .....	9
4.2 Mounting the Inverter .....	11
4.3 Electrical Connections .....	13
4.3.1 Connect PV side of inverter .....	13
4.3.2 Connect grid side of inverter .....	16
4.3.3 External ground connection .....	18
4.3.4 Max. overcurrent protection device (OCPD) .....	19
4.3.5 Inverter monitoring connection .....	19
4.3.6 Electrical connection diagram .....	20
4.3.7 CT connections .....	21
4.3.8 DRED port connections .....	21
5. Start & Stop .....	23
5.1 Start the Inverter .....	23
5.2 Stop the Inverter .....	23
6. Operation .....	24

# Contents

6.1 Main Menu .....	24
6.2 Information .....	24
6.2.1 Lock screen .....	26
6.3 Settings .....	26
6.3.1 Set Time .....	26
6.3.2 Set Address .....	26
6.4 Advanced Info. ....	27
6.4.1 Alarm Message .....	27
6.4.2 Running Message .....	28
6.4.3 Version .....	28
6.4.4 Daily Energy .....	28
6.4.5 Monthly Energy and Yearly Energy .....	28
6.4.6 Daily record .....	29
6.4.7 Communication Data .....	29
6.5 Advanced Settings .....	29
6.5.1 Select Standard .....	29
6.5.2 Grid ON/OFF .....	31
6.5.3 Clear Energy .....	31
6.5.4 New Password .....	31
6.5.5 Power control .....	31
6.5.6 Calibrate Energy .....	32
6.5.7 AUS STD. Settings .....	32
6.5.8 EMP Settings .....	34
7. Maintenance .....	36
8. Troubleshooting .....	36
9. Specifications .....	39
9.1 Technical data .....	39

# 1. Introduction

## 1.1 Product Description

Solis 4G mini series single phase inverters integrate DRM and backflow power control function, that could suitable for smart grid requirement.

Mini Single phase 4G series inverter contain 8 models which are listed below:  
 Solis-mini-700-4G, Solis-mini-1000-4G, Solis-mini-1500-4G, Solis-mini-2000-4G,  
 Solis-mini-2500-4G, Solis-mini-3000-4G, Solis-mini-3600-4G

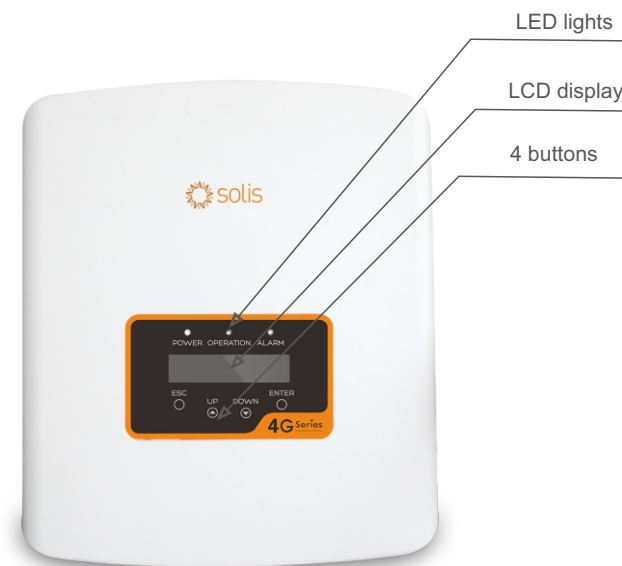

▲ Figure 1.1 Front side view

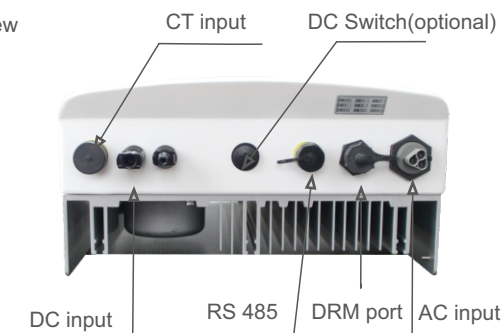

▲ Figure 1.2 Bottom side view

# 1. Introduction

# 2. Safety Instructions

## 1.2 Packaging

When you receive the inverter, ensure that all the parts listed below are included:



Part #	Description	Number
1	PV grid tie inverter	1
2	Wall/pole bracket	1
3	Locking screws	2
4	Grounding screw	1
5	DC connector	1pairs
6	AC connector	1
7	Manual	1
8	CT with cable (optional)	1

▲ Table 1.1 Parts list

Improper use may result in potential electric shock hazards or burns. This manual contains important instructions that should be followed during installation and maintenance. Please read these instructions carefully before use and keep them for future reference.

## 2.1 Safety Symbols

Safety symbols used in this manual, which highlight potential safety risks and important safety information, are listed as follows:



### WARNING:

WARNING symbol indicates important safety instructions, which if not correctly followed, could result in serious injury or death.



### NOTE:

NOTE symbol indicates important safety instructions, which if not correctly followed, could result in some damage or the destruction of the inverter.



### CAUTION:

CAUTION, RISK OF ELECTRIC SHOCK symbol indicates important safety instructions, which if not correctly followed, could result in electric shock.



### CAUTION:

CAUTION, HOT SURFACE symbol indicates safety instructions, which if not correctly followed, could result in burns.

## 2.2 General Safety Instructions



### WARNING:

Only devices in compliance with SELV (EN 69050) may be connected to the RS485 and USB interfaces.



### WARNING:

Please don't connect PV array positive(+) or negative(-) to ground, it could cause serious damage to the inverter.



### WARNING:

Electrical installations must be done in accordance with the local and national electrical safety standards.



### WARNING:

Do not touch any inner live parts until 5 minutes after disconnection from the utility grid and the PV input.



## 2. Safety Instructions

## 3. Overview



### WARNING:

To reduce the risk of fire, over-current protective devices (OCPD) are required for circuits connected to the Inverter. The DC OCPD shall be installed per local requirements. All photovoltaic source and output circuit conductors shall have disconnects that comply with the NEC Article 690, Part II. All Solis single phase inverters feature an integrated DC switch.



### CAUTION:

Risk of electric shock. Do not remove cover. There is no user serviceable parts inside. Refer servicing to qualified and accredited service technicians.



### CAUTION:

The PV array (Solar panels) supplies a DC voltage when they are exposed to sunlight.



### CAUTION:

Risk of electric shock from energy stored in capacitors of the Inverter. Do not remove cover for 5 minutes after disconnecting all power sources (service technician only). Warranty may be voided if the cover is removed without authorization.



### CAUTION:

The surface temperature of the inverter can reach up to 75°C (167 F). To avoid risk of burns, do not touch the surface of the inverter while it's operating. Inverter must be installed out of the reach of children.



PV module used with inverter must have an IEC 61730 Class A rating.

## 2.3 Notice For Use

The inverter has been constructed according to the applicable safety and technical guidelines. Use the inverter in installations that meet the following specifications ONLY:

1. Permanent installation is required.
2. The electrical installation must meet all the applicable regulations and standards.
3. The inverter must be installed according to the instructions stated in this manual.
4. The inverter must be installed according to the correct technical specifications.
5. To startup the inverter, the Grid Supply Main Switch (AC) must be switched on, before the solar panel's DC isolator shall be switched on. To stop the inverter, the Grid Supply Main Switch (AC) must be switched off before the solar panel's DC isolator shall be switched off.

## 3.1 Front Panel Display

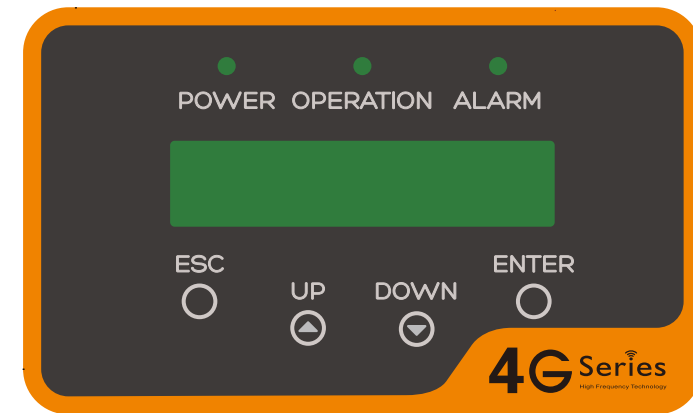

▲ Figure 3.1 Front Panel Display

## 3.2 LED Status Indicator Lights

There are three LED status indicator lights in the front panel of the inverter. Left LED: POWER LED (red) indicates the power status of the inverter. Middle LED: OPERATION LED (green) indicates the operation status. Right LED: ALARM LED (yellow) indicates the alarm status. Please see Table 3.1 for details

Light	Status	Description
● POWER	ON	The inverter can detect DC power
	OFF	No DC power or low DC power
● OPERATION	ON	The inverter is operating properly.
	OFF	The inverter has stopped to supply power.
	FLASHING	The inverter is initializing.
● ALARM	ON	Alarm or fault condition is detected.
	OFF	The inverter is operating properly.

▲ Table 3.1 Status Indicator Lights

## 3. Overview

### 3.3 Keypad

There are four keys in the front panel of the Inverter(from left to right): ESC, UP, DOWN and ENTER keys. The keypad is used for:

- Scrolling through the displayed options (the UP and DOWN keys);
- Access to modify the adjustable settings (the ESC and ENTER keys).

### 3.4 LCD

The two-line Liquid Crystal Display (LCD) is located on the front panel of the Inverter, which shows the following information:

- Inverter operation status and data;
- Service messages for operator;
- Alarm messages and fault indications.

## 4. Installation

### 4.1 Select a Location for the Inverter

To select a location for the inverter, the following criteria should be considered:

- Do not install in small closed spaces where air can not circulate freely. To avoid overheating, always make sure the flow of air around the inverter is not blocked.
- Exposure to direct sunlight will increase the operational temperature of the inverter and may cause output power limiting. Ginlong recommends inverter installed to avoid direct sunlight or raining.
- To avoid over heating ambient air temperature MUST be considered when choosing the inverter installation location. Ginlong recommends using a sun shade minimizing direct sunlight when the ambient air temperature around the unit exceeds 104°F/40°C.



Figure 4.1 Recommended Installation locations

# 4. Installation

- Install on a wall or strong structure capable of bearing the weight.
- Install vertically with a maximum incline of +/- 5° . If the mounted inverter is tilted to an angle greater than the maximum noted, heat dissipation can be inhibited, and may result in less than expected output power.
- When 1 or more inverters are installed in one location, a minimum 300mm clearance should be kept between each inverter or other object. The bottom of the inverter should be 500mm clearance to the ground.

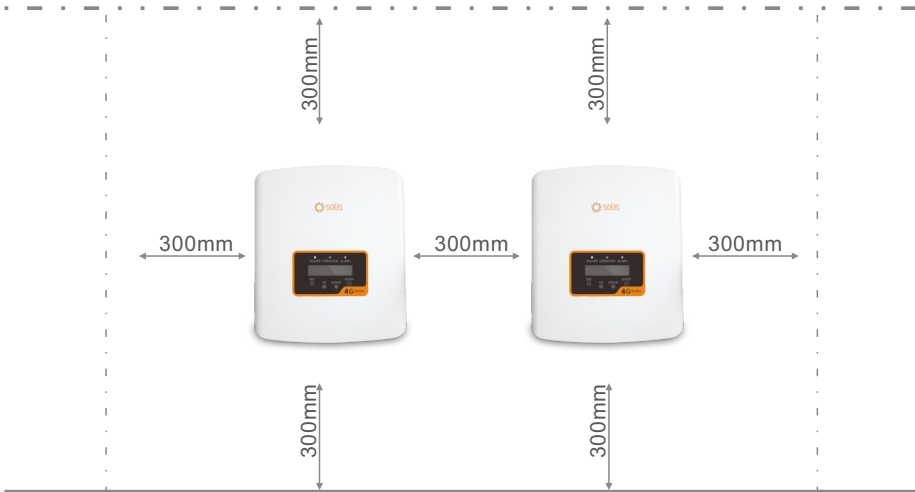

▲ Figure 4.2 Inverter Mounting clearance

- Visibility of the LED status indicator lights and the LCD located at the front panel of the inverter should be considered.
- Adequate ventilation must be provided if the inverter is to be installed in a confined space.



**NOTE:**

Nothing should be stored on or placed against the inverter.

# 4. Installation

## 4.2 Mounting the Inverter

Dimensions of wall bracket:

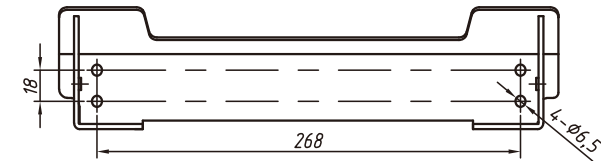

▲ Figure 4.3 Inverter wall mounting

Please see Figure 4.4 and Figure 4.5 for instruction on mounting the inverter.

The inverter shall be mounted vertically. The steps to mount the inverter are listed below:

1. According to the figure 4.2, select the mounting height of the bracket and mark the mounting holes. For brick walls, the position of the holes should be suitable for the expansion bolts.

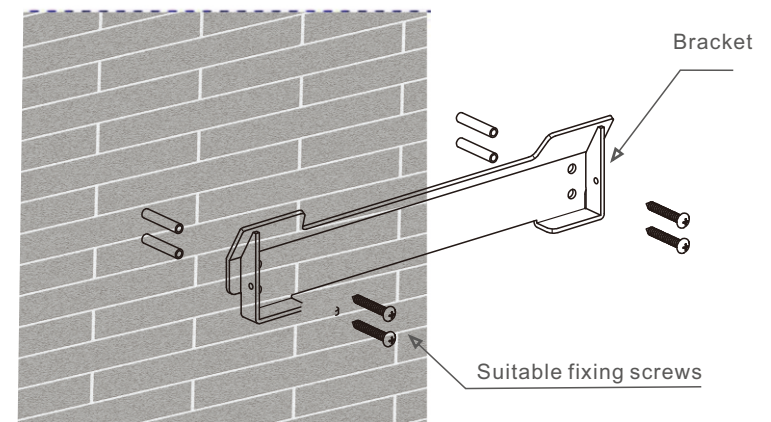

▲ Figure 4.4 Inverter wall mounting

# 4. Installation

2. Make sure the bracket is horizontal and the mounting holes (in Figure 4.4) are marked correctly. Drill the holes into the wall or pillar at your marks.
3. Use the suitable screws to fix the bracket to the wall.



**WARNING:**  
The inverter must be mounted vertically.

4. Lift up the inverter (be careful to avoid body strain), and align the back bracket on the inverter with the convex section of the mounting bracket. Hang the inverter on the mounting bracket and make sure the inverter is secure (see Figure 4.6)

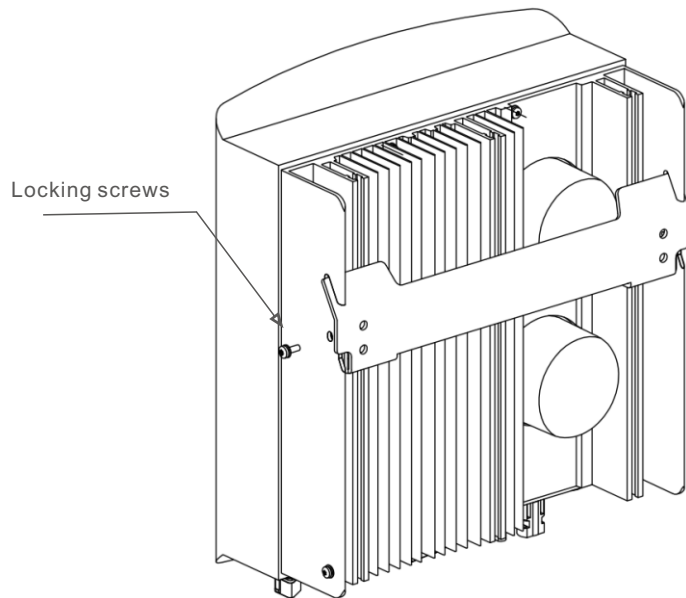

▲ Figure 4.5 Wall Mount Bracket

5. Use M4\*9 screws in accessory to lock the inverter to the mount bracket.

# 4. Installation

## 4.3 Electrical Connections

### 4.3.1 Connect PV side of inverter

The electrical connection of the inverter must follow the steps listed below:

1. Switch the Grid Supply Main Switch (AC) OFF.
2. Switch the DC Isolator OFF.
3. Assemble PV input connector to the Inverter.



Before connecting inverter, please make sure the PV array open circuit voltage is within the limit of the inverter

#### Maximum 600Voc for

Solis-mini-700-4G, Solis-mini-1000-4G, Solis-mini-1500-4G,  
Solis-mini-2000-4G, Solis-mini-2500-4G, Solis-mini-3000-4G,  
Solis-mini-3600-4G



Please don't connect PV array positive or negative pole to the ground, it could cause serious damages to the inverter



Before connection, please make sure the polarity of the output voltage of PV array matches the "DC+" and "DC-" symbols.



▲ Figure 4.6 DC+ Connector



▲ Figure 4.7 DC- Connector



# 4. Installation

# 4. Installation



Please use approved DC cable for PV system.

Cable type	Cross section	
	Range	Recommended value
Industry generic PV cable (model:PV1-F)	4.0~6.0 (12~10AWG)	4.0 (12AWG)

▲ Table 4.1 DC cable

The steps to assemble the DC connectors are listed as follows:

i) Strip off the DC wire for about 7mm, Disassemble the connector cap nut.

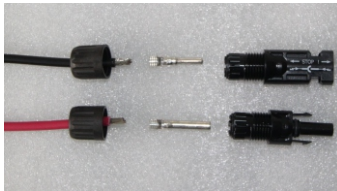

▲ Figure 4.8 Disassemble the Connector Cap nut

ii) Insert the wire into the connector cap nut and contact pin.

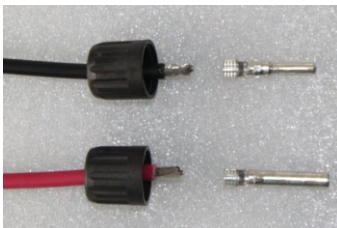

▲ Figure 4.9 Insert the Wire into the Connector Cap nut and contact pin

iii) Crimp the contact pin to the wire using a proper wire crimper.

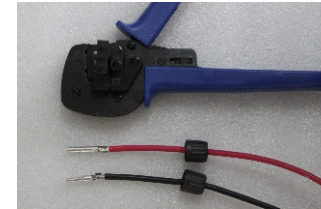

▲ Figure 4.10 Crimp the contact pin to the wire

iv) Insert the contact pin to the top part of the connector and screw up the cap nut to the top part of the connector.

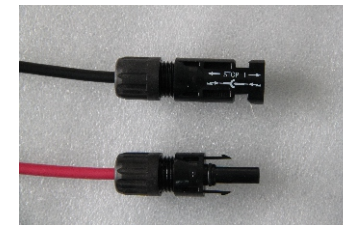

▲ Figure 4.11 Connector with Cap nut Screwed on

v) Then connect the DC connectors to the inverter. Small click will confirm connection.



▲ Figure 4.12 Connect the DC Connectors to the Inverter

# 4. Installation

# 4. Installation

## 4.3.2 Connect grid side of inverter

For all AC connections, 2.5- 6mm<sup>2</sup> 105 °C cable is required to be used. Please make sure the resistance of cable is lower than 1 ohm. If the wire is longer than 20m, it's recommended to use 6mm<sup>2</sup> cable.



**WARNING:**

There are “L” “N” “⏏” symbols marked inside the connector ( see Figure 4.11), the Line wire of grid must be connected to “L” terminal; the Neutral wire of grid must be connected to “N” terminal; the Earth of grid must be connected to “⏏” (see Figure 4.11).

Cable type	Cross section	
	Range	Recommended value
Industry generic grid cable	2.5~6.0mm <sup>2</sup>	6mm <sup>2</sup>

▲ Table 4.2 Grid cable size



▲ Figure 4.13 AC Grid Terminal Connector Inside

Each Solis Mini Single Phase Inverter is supplied with an AC grid terminal connector.



▲ Figure 4.14 AC Grid Terminal Connector

The steps to assemble the AC grid terminal connectors are listed as follows:

a) Disassemble the AC connector. Strip the AC wires about 6mm,

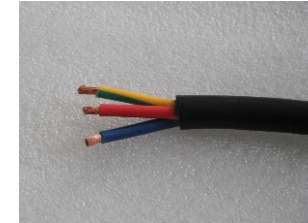

▲ Figure 4.15 Stripped AC Wires

b) Fix the green and yellow wire to the ground terminal. Fix the red(or brown) wire to L (line) terminal. Fix the blue wire to N(Neutral). Tight the screws on the connector. Please try to pull out the wire to make sure the it's well connected.



▲ Figure 4.16 Connect Wires to the Terminal

c) Tighten up the cap on the terminal (as shown in Figure 4.15).

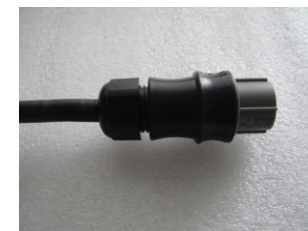

▲ Figure 4.17 Tighten up the Cap on the Terminal

# 4. Installation

# 4. Installation

d) Connect the AC grid terminal connector to the inverter. Small click will confirm connection.



▲ Figure 4.18 Connect the AC Connector to the Inverter



**Note: Connection for Split phase grid.**

When connect to 208/220/240V split phase, please connect L1 to “L” terminal, L2 to “N” terminal. Also connect earth to ground terminal.

### 4.3.3 External ground connection

An external ground connection is provided at the right side of inverter. Prepare OT terminals: M4. Use proper tooling to crimp the lug to the terminal. Connect the OT terminal with ground cable to the right side of inverter. The torque is 20 in-lbs (2Nm).

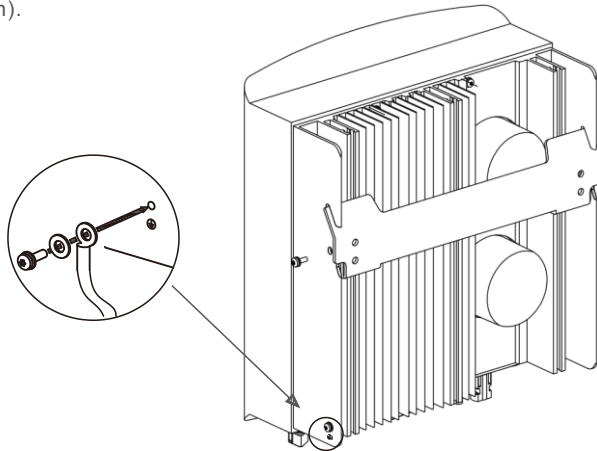

▲ Figure4.19 Connect the external grounding conductor

### 4.3.4 Max. over current protection device (OCPD)

To protect the inverter's AC grid connection conductors, Ginlong Solis recommends installing breakers that will protect against overcurrent. The following table defines OCPD ratings for the Ginlong Solis 6-10kW single phase inverters.

Inverter	Rated voltage(V)	Rated output power (kW)	Current for protection device (A)
Solis-mini-700-4G	230V/240V	0.7	10
Solis-mini-1000-4G	230V/240V	1	10
Solis-mini-1500-4G	230V/240V	1.5	10
Solis-mini-2000-4G	230V/240V	2	15
Solis-mini-2500-4G	230V/240V	2.5	15
Solis-mini-3000-4G	230V/240V	3	20
Solis-mini-3600-4G	230V/240V	3.6	20

▲ Table 4.3 Rating of grid OCPD

### 4.3.5 Inverter monitoring connection

The inverter can be monitored via Wi-Fi or GPRS. All Ginlong Solis communication devices are optional (Figure 4.9). For connection instructions, please refer to the Ginlong Solis Monitoring Device installation manuals.

# 4. Installation

# 4. Installation

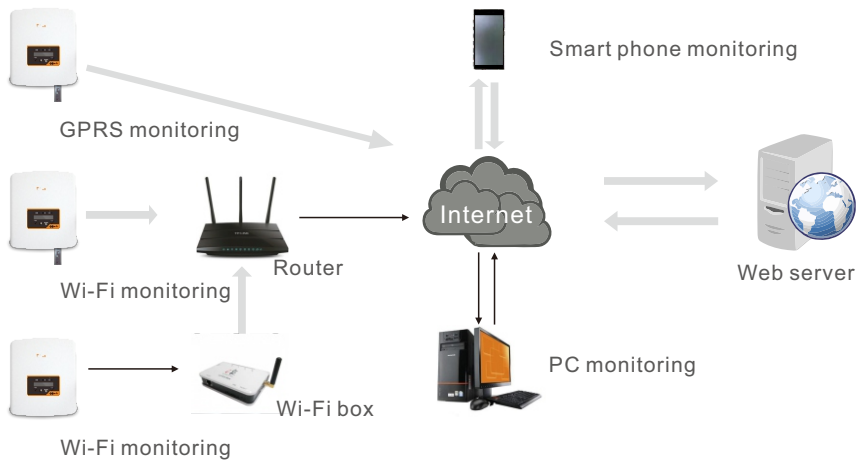

▲ Figure4.20 Wi-Fi communication function

1. The RCD should not be placed between the consumers mains and the solar supply.
2. More than one RCD may be used. Each RCD can protect one or more circuits.

### 4.3.7 CT connections(optional)

For inverter that integrate backflow power control module, that CT must be connected. The CT with cable in accessory is used for detect the total current of inverter and local equipment. The direction of CT must be installed correctly in order to make inverter detect right current.

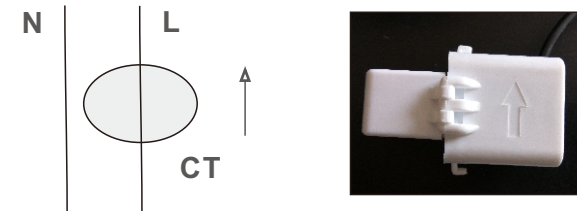

▲ Figure 4.22 Direction of CT

### 4.3.6 Electrical connection diagram

Figure 4.19 is a simple guidance for installing a solar system with PV inverter. A DC isolator is required to be installed in the system between the PV panels and the inverter.

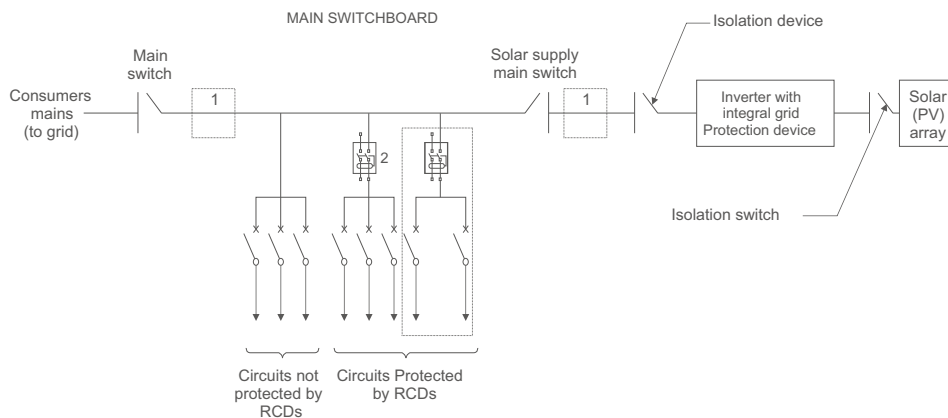

▲ Figure 4.21 Guidance for a Simple Installation of an Inverter Solar Energy System

### 4.3.8 DRED port connections

DRED means demand response enable device. The AS/NZS 4777.2 required inverter need to support demand response mode(DRM). This function is for inverter that comply with AS/NZS 4777.2 standard. Ginlong 4G single phase inverter is fully comply with all DRM. A RJ45 terminal is used for DRM connection.

Pin	Assignment for inverters capable of both charging and discharging
1	DRM 1/5
2	DRM 2/6
3	DRM 3/7
4	DRM 4/8
5	RefGen
6	Com/DRM0
7	V+
8	V-

## 4. Installation



### NOTE:

Ginlong 4G inverter is designed to provide 12V power for DRED.

Please follow below steps to assemble Rj45 connector.

1. Insert the network cable into the communication connection terminal of RJ45.  
(As shown in figure 5.24)



▲ Figure 4.23 RJ45 communication connection terminals

2. Use the network wire stripper to strip the insulation layer of the communication cable.  
According to the standard line sequence of table 4.3 connect the wire to the plug of RJ45, and then use a network cable crimping tool to make it tight.

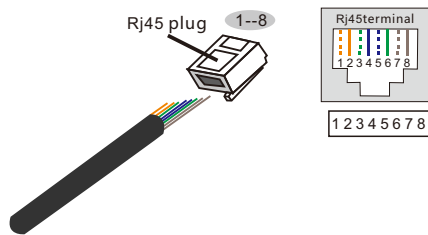

### Correspondence between the cables and the stitches of plug

Pin 1: white and orange ; Pin 2: orange  
Pin 3: white and green ; Pin 4: blue  
Pin 5: white and blue ; Pin 6: green  
Pin 7: white and brown ; Pin 8: brown

▲ Figure 4.24 Strip the insulation layer and connect to RJ45 plug

3. Connect RJ45 to DRM port

## 5. Start & Stop

### 5.1 Start the Inverter

To start up the Inverter, it is important that the following steps are strictly followed:

1. Switch the grid supply main Switch (AC) ON first.
2. Switch the DC switch ON. If the voltage of PV arrays are higher than start up voltage, the inverter will turn on. The red LED power will light.
3. When both the DC and the AC sides supply to the inverter, it will be ready to generate power. Initially, the inverter will check both its internal parameters and the parameters of the AC grid, to ensure that they are within the acceptable limits. At the same time, the green LED will flash and the LCD displays the information of INITIALIZING.
4. After 30-300 seconds (depending on local requirement), the inverter will start to generate power. The green LED will be on continually and the LCD displays GENERATING.



### WARNING:

Do not touch the surface when the inverter is operating. It may be hot and cause burns.

#### 5.1.1 Inverter working status

When inverter working normally, there would be 5 status :

- Generating: Inverter is working normally
- LimByTemp: Inverter power limited by over ambient temperature.
- LimByFreq: Inverter power limited by over grid frequency
- LimByVg: Inverter power limited by over grid voltage
- LimByVar: Inverter power limited by generating reactive power.

### 5.2 Stop the Inverter

To stop the Inverter, the following steps must be strictly followed:

1. Switch the Supply Main Switch (AC) OFF.
2. Wait 30 seconds. Switch the DC Switch OFF. All the LEDs of the inverter will be off in one minute.

During normal operation, the display alternately shows the power and the operation status with each screen lasting for 10 seconds (see Figure 6.1). Screens can also be scrolled manually by pressing the UP and DOWN keys. Press the ENTER key to access to the Main Menu.

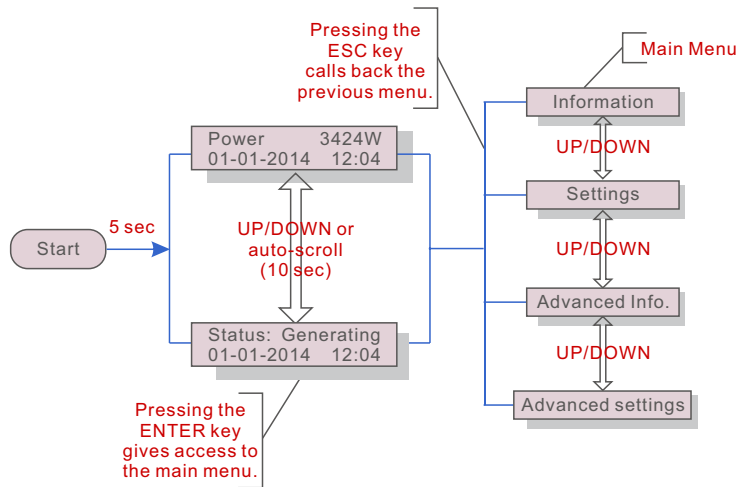

▲ Figure 6.1 Operation Overview

## 6.1 Main Menu

There are four submenus in the Main Menu (see Figure 6.1):

1. Information
2. Settings
3. Advanced Info.
4. Advanced Settings

## 6.2 Information

The Solis Mini Single Phase 4G Inverter main menu provides access to operational data and information. The information is displayed by selecting "Information" from the menu and then by scrolling up or down.

Display	Duration	Description
V_DC1 350.8V I_DC1 5.1A	10 sec	V_DC1: Shows input 01 voltage value. I_DC1: Shows input 01 current value.
V_Grid 230.4V I_Grid 8.1A	10 sec	V_Grid: Shows the grid's voltage value I_Grid: Shows the grid's current value.
Status: Generating Power: 1488W	10 sec	Status: Shows instant status of the Inverter. Power: Shows instant output power value.
Grid Frequency F_Grid 60.06Hz	10 sec	F_Grid: Shows the grid's frequency value.
Total Energy 0258458 kwh	10 sec	Total generated energy value
This Month: 0123kwh Last Month: 0123kwh	10 sec	This Month: Total energy generated this month. Last Month: Total energy generated last month.
Today: 15.1kwh Yesterday: 13.5kwh	10 sec	Today: Total energy generated today. Yesterday: Total energy generated yesterday.
Inverter SN 00000000000000	10 sec	Display series number of the inverter

▲ Table 6.1 Information list

## 6.2.1 Lock screen

Pressing the ESC key returns to the Main Menu. Pressing the ENTER key locks (Figure 6.2(a)) or unlocks (Figure 6.2 (b)) the screen.



▲ Figure 6.2 Locks and Unlocks the Screen of LCD

## 6.3 Settings

The following submenus are displayed when the Settings menu is selected:

- 1.Set Time
- 2.Set Address

### 6.3.1 Set Time

This function allows time and date setting. When this function is selected, the LCD will display a screen as shown in Figure 6.3.



NEXT=<ENT> OK=<ESC>  
01-01-2016 16:37

▲ Figure 6.3 Set Time

Press the UP/DOWN keys to set time and data. Press the ENTER key to move from one digit to the next (from left to right). Press the ESC key to save the settings and return to the previous menu.

### 6.3.2 Set Address

This function is used to set the address when multi inverters are connected to single monitor. The address number can be assigned from "01" to "99"(see Figure 6.4). The default address number of Solis Single Phase Inverter is "01".



YES=<ENT> NO=<ESC>  
Set Address: 01

▲ Figure 6.4 Set Address

Press the UP/DOWN keys to set the address. Press the ENTER key to save the settings. Press the ESC key to cancel the change and return to the previous menu.

## 6.4 Advanced Info - Technicians Only



### NOTE:

To access to this area is for fully qualified and accredited technicians only. Enter menu "Advanced Info." and "Advanced settings" (need password) .

Select "Advanced Info." from the Main Menu. The screen will require the password as below



YES=<ENT> NO=<ESC>  
Password:0000

▲ Figure 6.5 Enter password

The default password is "0010". Please press "down" to move the cursor, press "up" to select the number.

After enter the correct password the Main Menu will display a screen and be able to access to the following information.

- 1.Alarm Message
2. Running message
- 3.Version
4. Daily Energy
5. Monthly Energy
6. Yearly Energy
7. Daily Record
- 8.Communication Data

The screen can be scrolled manually by pressing the UP/DOWN keys. Pressing the ENTER key gives access to a submenu. Press the ESC key to return to the Main Menu.

### 6.4.1 Alarm Message

The display shows the 100 latest alarm messages (see Figure 6.6). Screens can be scrolled manually by pressing the UP/ DOWN keys. Press the ESC key to return to the previous menu.



Alarm001: OV-G-V  
Time: 27-11 Data: 7171

▲ Figure 6.6 Alarm Message



# 6. Operation

# 6. Operation

## 6.4.2 Running Message

This function is for maintenance person to get running message such as internal temperature, Standard NO. etc.  
Screens can be scrolled manually by pressing the UP/DOWN keys.

## 6.4.3 Version

The screen shows the model version and the software version of the Inverter (see Figure 6.7).



Model: 08  
Software Version: D20001

▲ Figure 6.7 Model Version and Software Version

## 6.4.4 Daily Energy

The function is for checking the energy generation for selected day.



YES=<ENT> NO=<ESC>  
Select: 2015-02-23

▲ Figure 6.8 Select date for daily energy

Press DOWN key to move the cursor to day, month and year, press UP key to change the digit. Press Enter after the date is fixed.

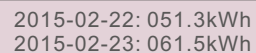

2015-02-22: 051.3kWh  
2015-02-23: 061.5kWh

▲ Figure 6.9 Daily energy

Press UP/DOWN key to move one date from another.

## 6.4.5 Monthly Energy and Yearly Energy

The two functions are for checking the energy generation for selected month and Year



YES=<ENT> NO=<ESC>  
Select: 2015-02



YES=<ENT> NO=<ESC>  
Select: 2015

▲ Figure 6.10 Select month for monthly energy ▲ Figure 6.11 Select year for yearly energy

Press DOWN key to move the cursor, press UP key to change the digit. Press Enter after the month/year is fixed.

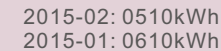

2015-02: 0510kWh  
2015-01: 0610kWh

▲ Figure 6.12 Month energy



2015: 0017513kWh  
2014: 0165879kWh

▲ Figure 6.13 Yearly energy

Press UP/DOWN key to move one date from another.

## 6.4.6 Daily record

The screen shows history of changing settings. Only for maintenance personnel.

## 6.4.7 Communication Data

The screen shows the internal data of the Inverter (see Figure 6.14), which is for service technicians only.

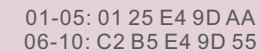

01-05: 01 25 E4 9D AA  
06-10: C2 B5 E4 9D 55

▲ Figure 6.14 Communication Data

## 6.5 Advanced Settings - Technicians Only



### NOTE:

To access to this area is for fully qualified and accredited technicians only. Please follow 6.4 to enter password to access this menu.

Select Advanced Settings from the Main Menu to access the following options:

1. Select Standard
2. Grid ON/OFF
3. Clear Energy
4. New Password
5. Power Control
6. Calibrate Energy
7. AUS STD. Settings

### 6.5.1 Selecting Standard

This function is used to select the grid's reference standard (see Figure 6.11).



YES=<ENT> NO=<ESC>  
Standard:AUS-Q-0.8

▲ Figure 6.15



# 6. Operation

# 6. Operation

Press the UP/DOWN keys to select the standard (AS4777, VDE4105, VDE0126, UL-240V-A, UL-208V-A, UL-240V, UL-208V, MEX-CFE, G83/2 (for 1-3.6kW models), G59/3 (for 4-5kW models), EN50438 DK, EN50438 IE, EN50438 NL and "User-Def" function). Press the ENTER key to confirm the setting. Press the ESC key to cancel changes and returns to previous menu.



**NOTE:**

This function is for technicians use only.

Selecting the "User-Def" menu will access to the following submenu (see Figure 6.16),

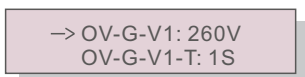

▲ Figure 6.16



**NOTE:**

The "User-Def" function can be only used by the service engineer and must be allowed by the local energy supplier.

Below is the setting range for "User-Def". Using this function, the limits can be changed manually.

OV-G-V1: 220---290V	OV-G-F1: 50.2-53Hz(60.2-64Hz)
OV-G-V1-T: 0.1---9S	OV-G-F1-T: 0.1---9S
OV-G-V2: 220---290V	OV-G-F2: 50.2-53Hz(60.2-64Hz)
OV-G-V2-T: 0.1---1S	OV-G-F2-T: 0.1---9S
UN-G-V1: 90---210V	UN-G-F1: 47-49.5Hz(56-59.8Hz)
UN-G-V1-T: 0.1---9S	UN-G-F1-T: 0.1---9S
UN-G-V2: 90---210V	UN-G-F2: 47-49Hz(56-59.8Hz)
UN-G-V2-T: 0.1---1S	UN-G-F2-T: 0.1---9S

Press the UP/DOWN keys to scroll through items. Press the ENTER key to edit the highlighted item. Press the UP/DOWN keys again to change the setting. Press the ENTER key to save the setting. Press the ESC key to cancel changes and returns to the previous menu.

## 6.5.2 Grid ON/OFF

This function is used to start up or stop the power generation of Solis Mini Single Phase 4G Inverter (see Figure 6.17).



▲ Figure 6.17 Set Grid ON/OFF

Screens can be scrolled manually by pressing the UP/DOWN keys. Press the ENTER key to save the setting. Press the ESC key to return to the previous menu.

## 6.5.3 Clear Energy

Clear Energy can reset the history yield of inverter



These two functions are applicable by maintenance personnel only, wrong operation will prevent the inverter from working properly.

## 6.5.4 New Password

This function is used to set the new password for menu "Advanced info." and "Advanced information" (see Figure 6.18).



▲ Figure 6.18 Set new password

Enter the right password before set new password. Press the DOWN key to move the cursor, Press the UP key to revise the value. Press the ENTER key to execute the setting. Press the ESC key to return to the previous menu.

## 6.5.5 Power control

Active and reactive power can be set through power setting button.

There are 5 item for this sub menu:

1. Set output power
2. Set Reactive Power
3. Out\_P With Restore
4. Rea\_P With Restore
5. Select PF Curve



This function is applicable by maintenance personnel only, wrong operation will prevent the inverter from reaching maximum power.

# 6. Operation

# 6. Operation

## 6.5.6 Calibrate Energy

Maintenance or replacement could clear or cause a different value of total energy. Use this function could allow user to revise the value of total energy to the same value as before. If the monitoring website is used the data will be synchronous with this setting automatically. (see Figure 6.19).

```
YES=<ENT> NO=<ESC>
Energy:000000kWh
```

▲ Figure 6.19 Calibrate energy

Press the DOWN key to move the cursor, Press the UP key to revise the value. Press the ENTER key to execute the setting. Press the ESC key to return to the previous menu.

## 6.5.7 AUS STD. Settings

This sub menu is enabled when the grid standard is set to AS4777. To comply with New AUS/ NZ 4777.2, Ginlong Solis 4G inverter could set different work mode to work with different grid requirement.

There are 4 setting under AUS STD settings.

- 1. Working mode 2. Power Rate limit 3. Freq. Derate set 4. 10mins OV-G-V set.**

There are 5 work mode in working mode submenu.

- 1. Fixed PF 2. Reac. Power 3. Power-PF 4. Volt-Watt 5. Volt-Var.**

The parameter in each model could be set as below:

### 1. Fixed PF

Set PF (-0.8, +0.8), Default 1, Resolution 0.01

### 2. Reac. Power

Set reactive power (0, 60%), Default 0, Resolution 1%

### 3. Power-PF

Set Pb\_Limit: 0-100%, Default 25%

Pc\_Limit: 0-100%, Default 50%

Pc\_Factor: (-0.8, +0.8), Default -0.95

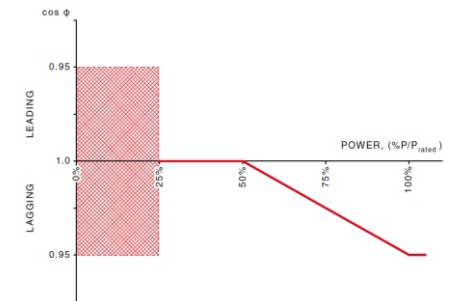

### 4. Volt-Watt

Set Voltage1: 207-220V, Default 207V

Set P\_Limit1: 20%-100%, Default 100%

Set Voltage2: 216-230V, Default 220V

Set P\_Limit2: 20%-100%, Default 100%

Set Voltage3: 235-255V, Default 250V

Set P\_Limit3: 20%-100%, Default 100%

Set Voltage4: 244-265V, Default 255V

Set P\_Limit4: 20%-100%, Default 100%

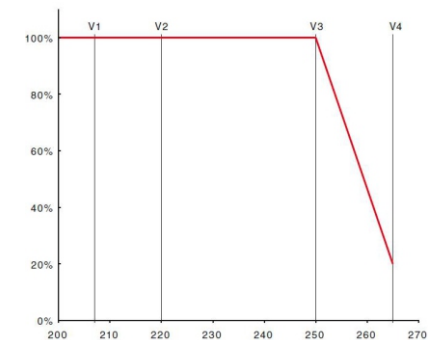

### 5. Volt-Var

Set Voltage1: 207-220V, Default 207V

Set Voltage2: 216-230V, Default 220V

Set Voltage3: 235-255V, Default 250V

Set Voltage4: 244-265V, Default 255V

Set Leading: 0~+60%, Default +30%

Set Lagging: 0~-60%, Default -30%

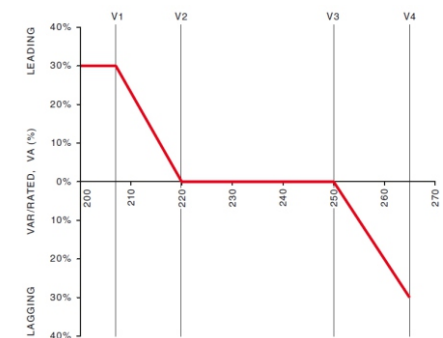

# 6. Operation

# 6. Operation

The other 3 setting in AUS STD. setting are as below:

## 1. Power Rate limit

Wgra: 0-100%, Default 16%

## 2. Freq. Derate set

Set Derate Mode:01

Set Freq.: 51-52Hz, Default 52Hz

## 3. 10mins OV-G-V set

10mins Voltage: 244-255V, Default 248V

## 6.5.8 EPM Settings



### NOTE:

To access to this area is for fully qualified and accredited technicians only.  
Please follow 6.4 to enter password to access this menu.

The default password is "0010". Please press "down" to move the cursor, press "up" to select the number.

Select EPM Settings from the Main Menu to access the following options:

1. Set Backflow Power
2. CT Sampling Ratio
3. EPM ON/OFF

### 6.5.8.1 Set Backflow Power

This submenu is used for set allowed power that inverter can generate to grid .

->Set Backflow Power

▲ Figure 6.20 Set the backflow power

YES=<ENT> NO=<ESC>  
P\_Backflow:-0001W

▲ Figure 6.21

Press the UP/DOWN keys to set data.Press the ENTER key to set backflow power  
Then press DOWN keys to move the cursor, press UP to change the number.  
Press the ESC key to save the settings and return to the previous menu.

### 6.5.8.2 CT Sampling Ratio

This function is used for change CT Sampling Ratio if customer select different CT.  
The default radio is 3000:1.

-> CT Sampling Ratio

▲ Figure 6.22 Set the CT Para of the EPM

YES=<ENT> NO=<ESC>  
Ratio:3000:1

▲ Figure 6.23

Press the UP/DOWN keys to set data.Press the ENTER key to set CT Para .  
Press the ESC key to save the settings and return to the previous menu.

### 6.5.8.3 EPM ON/OFF

This function is used to enable or disable backflow power control function.

YES=<ENT> NO=<ESC>  
EPM Set:ON

▲ Figure 6.24 Set the EPM ON/OFF

Press the UP/DOWN keys to set ON/OFF.Press the ENTER key to set done .  
Press the ESC key to the previous menu.

# 7. Maintenance

## 7. Maintenance

Solis Mini Single Phase 4G Inverter does not require any regular maintenance. However, cleaning the dust on heat-sink will help the inverter to dissipate the heat and increase its life time. The dust can be removed with a soft brush.



**CAUTION:**

Do not touch the inverter's surface when it is operating. Some parts of the inverter may be hot and cause burns. Turn off the inverter (refer to Section 5.2) and wait for a cool-down period before any maintenance or cleaning operation.

The LCD and the LED status indicator lights can be cleaned with a damp cloth if they are too dirty to be read.



**NOTE:**

Never use any solvents, abrasives or corrosive materials to clean the inverter.

# 8. Troubleshooting

The inverter is designed in accordance with the most important international grid-tied standards and safety and electromagnetic compatibility requirements. Before delivering to the customer, the inverter has been subjected to several tests to ensure its optimal operation and reliability.

In case of failure, the LCD screen will display an alarm message. In this case, the inverter may stop feeding into the grid. The failure descriptions and their corresponding alarm messages are listed in Table 8.1:

# 8. Trouble Shooting

Alarm Message	Failure description	Solution
No power	Inverter no power on LCD	1. Check PV input connections 2. Check DC input voltage (single phase >120V, three phase >350V) 3. Check if PV+/- is reversed
LCD show initializing all the time	can not start-up	1. Check if the connector on main board or power board are fixed. 2. Check if the DSP connector to power board are fixed.
OV-G-V01/02/03/04	Over grid voltage	1. Resistant of AC cable is too high. Change bigger size grid cable 2. Adjust the protection limit if it's allowed by electrical company.
UN-G-V01/02	Under grid voltage	1. Use user define function to adjust the protection limit if it's allowed by electrical company.
OV-G-F01/02	Over grid frequency	
UN-G-F01/02	Under grid frequency	
G-IMP	High grid impedance	
NO-GRID	No grid voltage	1. Check connections and grid switch. 2. Check the grid voltage inside inverter terminal.
OV-DC01/02/03/04	Over DC voltage	1. Reduce the module number in series
OV-BUS	Over DC bus voltage	1. Check inverter inductor connection 2. Check driver connection
UN-BUS01/02	Under DC bus voltage	
GRID-INTF01/02	Grid interference	1. Restart inverter 2. Change power board
OV-G-I	Over grid current	
IGBT-OV-I	Over IGBT current	
DC-INTF OV-DCA-I	DC input overcurrent	1. Restart inverter 2. Identify and remove the string to the fault MPPT 2. Change power board
IGFOL-F	Grid current tracking fail	1. Restart inverter or contact installer.
IG-AD	Grid current sampling fail	
OV-TEM	Over Temperature	1. Check inverter surrounding ventilation. 2. Check if there's sunshine direct on inverter in hot weather.
INI-FAULT	Initialization system fault	1. Restart inverter or contact installer.
DSP-B-FAULT	Comm. failure between main and slave DSP	
12Power-FAULT	12V power supply fault	
GROUND-FAULT 01/02	Ground fault	1. Remove all DC input, reconnect and restart inverter one by one. 2. Identify which string cause the fault and check the isolation of the string.

## 8. Trouble Shooting

Alarm Message	Failure description	Solution
lLeak-FAULT 01/02/03/04	High Grid leakage current	1.Check AC and DC connection 2.Check inverter inside cable connection.
Relay-FAULT	Relay check fault	1.Restart inverter or contact installer.
DCinj-FAULT	High DC injection current	1.Restart inverter or contact installer.
AFCI Check FAULT	AFCI module self check fault	1.Restart inverter or contact installer.
ARC-FAULT	ARC detected in DC circuit	1.Check if there's arc in PV connection and restart inverter.

▲ Table 8.1 Fault message and description



### NOTE:

If the inverter displays any alarm message as listed in Table 8.1; please turn off the inverter (refer to Section 5.2 to stop your inverter) and wait for 5 minutes before restarting it (refer to Section 5.1 to start your inverter). If the failure persists, please contact your local distributor or the service center. Please keep ready with you the following information before contacting us.

1. Serial number of Solis Single Phase Inverter;
2. The distributor/dealer of Solis Single Phase Inverter (if available);
3. Installation date.
4. The description of problem (i.e. the alarm message displayed on the LCD and the status of the LED status indicator lights. Other readings obtained from the Information submenu (refer to Section 6.2) will also be helpful.);
5. The PV array configuration (e.g. number of panels, capacity of panels, number of strings, etc.);
6. Your contact details.

## 9. Specifications

### 9.1 Technical data

Model	Solis-mini-700-4G	Solis-mini-1000-4G
Max power per MPPT (Watts)	900	1200
Max voltage (Volts)		600
Startup voltage (Volts)		60
Operating MPPT voltage range (Volts)		50...500
Max. Inverter Backfeed Current to the Array (Aac)		0
Max usable input current per MPPT (Amps)		11
Max short circuit input current (Amps)		17.2
Number of MPPT		1
Inputs per MPPT		1
Nominal output power(Watts)	700	1000
Max. output power(Watts)	800	1100
Max. apparent output power(VA)	800	1100
Nominal grid voltage (Volts)		230/240
Operating voltage range (Volts)		160...285V
Max. overcurrent protection device(Amps)		10
Rated output current(Amps)	4.3	4.3
Output power factor range		0.8leading...0.8lagging
Current(inrush)(Peak and Duration)		0
Max. Output Fault Current(Aac)		35
Grid current THD		<1.5%
Nominal grid frequency (Hertz)		50/60
Operating frequency range (Hertz)		47...52 or 57...62
Peak efficiency		97.2%
CEC weighted efficiency		96.5%
MPPT efficiency		>99.5%
Rapid shutdown		Optional
Dimensions(cm)		310W*373H*160D
Weight(kg)		7.4kg
Topology		Transformerless
Ambient operating temperature range		-25°C...60°C
Enclosure type		Ip65
Noise emission (typical)		<30 dBA
Cooling concept		Natural convection
Max. operating altitude without derating		4000m
Designed lifetime		>20 years
Compliance		EN50438, G83/2, AS4777.2:2015, VDE0126-1-1, IEC61727, VDE N4105
Operating surroundings humidity		0...100% Condensing
Connection		Mc4 connector and Ip67 rated plug
Display		LCD, 2*20 Z.
Interface		RS 485, WIFI/GPRS (optional)
Warranty Terms		5 Years STD (Extendable to 20 Years)

# 9. Specifications

Model	Solis-mini-1500-4G	Solis-mini-2000-4G
Max power per MPPT (Watts)	1800	2300
Max voltage (Volts)	600	
Startup voltage (Volts)	60	
Operating MPPT voltage range (Volts)	50...500	
Max. Inverter Backfeed Current to the Array (A dc)	0	
Max usable input current per MPPT (Amps)	11	
Max short circuit input current (Amps)	17.2	
Number of MPPT	1	
Inputs per MPPT	1	
Nominal output power(Watts)	1500	2000
Max. output power(Watts)	1700	2200
Max. apparent output power(VA)	1700	2200
Nominal grid voltage (Volts)	230/240	
Operating voltage range (Volts)	160...285V	
Max. overcurrent protection device(Amps)	15	
Rated output current(Amps)	6.5	8.7
Output power factor range	0.8leading~0.8lagging	
Current(inrush)(Peak and Duration)	0	
Max. Output Fault Current(Aac)	35	
Grid current THD	<1.5%	
Nominal grid frequency (Hertz)	50/60	
Operating frequency range (Hertz)	47...52 or 57...62	
Peak efficiency	97.2%	
CEC weighted efficiency	96.5%	
MPPT efficiency	>99.5%	
Rapid shutdown	Optional	
Dimensions(cm)	310W*373H*160D	
Weight(kg)	7.4kg	
Topology	Transformerless	
Ambient operating temperature range	-25°C . . . 60°C	
Enclosure type	Ip65	
Noise emission (typical)	<30 dBA	
Cooling concept	Natural convection	
Max. operating altitude without derating	4000m	
Designed lifetime	>20 years	
Compliance	EN50438, G83/2, AS4777.2:2015, VDE0126-1-1, IEC61727, VDE N4105	
Operating surroundings humidity	0...100% Condensing	
Connention	Mc4 connector and Ip67 rated plug	
Display	LCD, 2×20 Z.	
Interface	RS 485, WIFI/GPRS (optional)	
Warranty Terms	5 Years STD (Extendable to 20 Years)	

# 9. Specifications

Model	Solis-mini-2500-4G	Solis-mini-3000-4G
Max power per MPPT (Watts)	3000	3500
Max voltage (Volts)	600	
Startup voltage (Volts)	100	
Operating MPPT voltage range (Volts)	100....500	
Max. Inverter Backfeed Current to the Array (A dc)	0	
Max usable input current per MPPT (Amps)	11	
Max short circuit input current (Amps)	17.2	
Number of MPPT	1	
Inputs per MPPT	1	
Nominal output power(Watts)	2500	3000
Max. output power(Watts)	2800	3300
Max. apparent output power(VA)	2800	3300
Nominal grid voltage (Volts)	230/240	
Operating voltage range (Volts)	160...285V	
Max. overcurrent protection device(Amps)	20	
Rated output current(Amps)	10.9	13
Output power factor range	0.8leading...0.8lagging	
Current(inrush)(Peak and Duration)	0	
Max. Output Fault Current(Aac)	45	
Grid current THD	<1.5%	
Nominal grid frequency (Hertz)	50/60	
Operating frequency range (Hertz)	47...52 or 57...62	
Peak efficiency	97.5%	
CEC weighted efficiency	96.8%	
MPPT efficiency	>99.5%	
Rapid shutdown	Optional	
Dimensions(cm)	310W*373H*160D	
Weight(kg)	7.7kg	
Topology	Transformerless	
Ambient operating temperature range	-25°C . . . 60°C	
Enclosure type	Ip65	
Noise emission (typical)	<30 dBA	
Cooling concept	Natural convection	
Max. operating altitude without derating	4000m	
Designed lifetime	>20 years	
Compliance	EN50438, G83/2, AS4777.2:2015, VDE0126-1-1, IEC61727, VDE N4105	
Operating surroundings humidity	0...100% Condensing	
Connention	Mc4 connector and Ip67 rated plug	
Display	LCD, 2×20 Z.	
Interface	RS 485, WIFI/GPRS (optional)	
Warranty Terms	5 Years STD (Extendable to 20 Years)	

# 9. Specifications

Model	Solis-mini-3600-4G
Max power per MPPT (Watts)	4000
Max voltage (Volts)	600
Startup voltage (Volts)	100
Operating MPPT voltage range (Volts)	100...500
Max. Inverter Backfeed Current to the Array (Adc)	0
Max usable input current per MPPT (Amps)	11
Max short circuit input current (Amps)	17.2
Number of MPPT	1
Inputs per MPPT	1
Nominal output power(Watts)	3600
Max. output power(Watts)	3600
Max. apparent output power(VA)	3600
Nominal grid voltage (Volts)	230/240
Operating voltage range (Volts)	160...285V
Max. overcurrent protection device(Amps)	25
Rated output current(Amps)	13
Output power factor range	0.8leading...0.8lagging
Current(inrush)(Peak and Duration)	0
Max. Output Fault Current(Aac)	45
Grid current THD	<1.5%
Nominal grid frequency (Hertz)	50/60
Operating frequency range (Hertz)	47...52 or 57...62
Peak efficiency	97.5%
CEC weighted efficiency	96.8%
MPPT efficiency	>99.5%
Rapid shutdown	Optional
Dimensions(cm)	310W*373H*160D
Weight(kg)	7.7kg
Topology	Transformerless
Ambient operating temperature range	-25°C. . . 60°C
Enclosure type	Ip65
Noise emission (typical)	<30 dBA
Cooling concept	Natural convection
Max. operating altitude without derating	4000m
Designed lifetime	>20 years
Compliance	EN50438, G83/2, AS4777.2:2015, VDE0126-1-1, IEC61727, VDE N4105
Operating surroundings humidity	0...100% Condensing
Connention	Mc4 connector and Ip67 rated plug
Display	LCD, 2×20 Z.
Interface	RS 485, WIFI/GPRS (optional)
Warranty Terms	5 Years STD (Extendable to 20 Years)